

## **PHONECELL® SX4e**

**TDMA 800 MHz VOICE/FAX/DATA  
and  
DIGITAL TRI-MODE (TDMA/PCS/AMPS)  
VOICE/FAX/DATA**

*TECHNICAL MANUAL*

## CONTENTS



Phonecell SX4e  
Fixed Wireless Terminal (FWT)



Spike Antenna

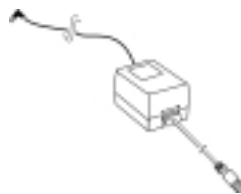

Power Supply

Before installing your **Phonecell SX4e**, carefully remove the unit from the shipping carton and check for evidence of shipping damage. **If damage is found, contact your Authorized Telular Distributor or shipping agent immediately.** Next, make sure you have the following components:

- Phonecell SX4e Fixed Wireless Terminal (FWT)
- Antenna
- Power Supply and AC Line Cord

## SAFE OPERATION INSTRUCTIONS

**IMPORTANT!** Before installing or operating this product, read the **SAFETY AND GENERAL INFORMATION** located at the end of this guide.

- Install unit indoors.
- Install unit on hard, flat surface for proper ventilation.
- Do not expose unit to rain or moisture.
- Do not place unit on or close to sources of heat.

**PLEASE SEE THE IMPORTANT NOTICES SECTION OF THIS GUIDE FOR IMPORTANT INFORMATION ON USE, WARRANTY AND INDEMNIFICATION**

## IMPORTANT NOTICES

### **TERMS AND CONDITIONS FOR USE OF PHONECELL® PRODUCTS ("Product")**

These Terms and Conditions are a legal contract between you and Telular Corporation for the title to and use of the Product. BY RETAINING AND USING THE PRODUCT AFTER RECEIPT OF IT, YOU AGREE TO THE TERMS AND CONDITIONS INCLUDING WARRANTY DISCLAIMERS, LIMITATIONS OF LIABILITY AND INDEMNIFICATION PROVISIONS BELOW. IF YOU DO NOT AGREE TO THE TERMS AND CONDITIONS, DO NOT USE THE PRODUCT AND IMMEDIATELY RETURN THE UNUSED PRODUCT FOR A COMPLETE REFUND. You agree to accept sole responsibility for any misuse of the Product by you; and, in addition, any negligent or illegal act or omission of you or your agents, contractors, servants, employees, or other users of the Product so long as the Product was obtained from you, in the use and operation of the Product.

### **INDEMNIFICATION OF TELULAR CORPORATION ("TELULAR")**

YOU SHALL INDEMNIFY, DEFEND AND HOLD HARMLESS TELULAR FOR ANY OF THE COST, INCLUDING REASONABLE ATTORNEYS' FEES, AND FROM CLAIMS ARISING OUT OF YOU, YOUR CLIENTS' OR OTHER THIRD PARTIES' USE OR OPERATION OF THE PRODUCT: (i) FOR MISUSE OR IN A MANNER NOT CONTEMPLATED BY YOU AND TELULAR OR INCONSISTENT WITH THE PROVISIONS OF THIS MANUAL; (ii) IN AN ILLEGAL MANNER OR AGAINST PUBLIC POLICY; (iii) IN A MANNER SPECIFICALLY UNAUTHORIZED IN THIS MANUAL; (iv) IN A MANNER HARMFUL OR DANGEROUS TO THIRD PARTIES; (v) FROM CLAIMS BY ANYONE RESPECTING PROBLEMS, ERRORS OR MISTAKES OF THE PRODUCT; OR (vi) COMBINATION OF THE PRODUCT WITH MATERIAL, MODIFICATION OF THE PRODUCT OR USE OF THE PRODUCT IN AN ENVIRONMENT NOT PROVIDED, OR PERMITTED, BY TELULAR IN WRITING. THE PARTIES SHALL GIVE EACH OTHER PROMPT NOTICE OF ANY SUCH COST OR CLAIMS AND COOPERATE, EACH WITH THE OTHER, TO EFFECTUATE THIS INDEMNIFICATION, DEFENSE AND HOLD HARMLESS.

### **TELULAR CORPORATION**

#### **Corporate Headquarters**

647 North Lakeview Parkway  
Vernon Hills, Illinois 60061, USA

#### **Technical Support**

USA: 1-800-TELULAR (1-800-835-8527)

Tel: 847-247-9400 • Fax: 847-247-0021

E-mail: support@telular.com • <http://www.telular.com>

## **TABLE OF CONTENTS**

<b>Safe Operation Instructions</b> .....	2
<b>Important Notices</b> .....	2
Technical Support.....	2
<b>Installation</b> .....	4
Antenna Location and Setup.....	4
Optional Wall-Mount Installation .....	4
Connect Your SX4e to AC Power .....	5
Plug in Your Telephone .....	6
<b>How to Set Up Your Phone Number</b> .....	7
<b>Phonecell SX4e Operation</b> .....	8
How to Use the LED Status Indicators .....	8
How to Place a Call .....	8
How to Receive a Call .....	8
How to End a Call .....	8
The Hookflash Function .....	8
How to Use the Hookflash Function .....	8
Important Tones and Alerts .....	9
How to Adjust the Volume Level .....	9
Variable Dial Time (Auto Send Delay) Option.....	9
In-Call DTMF Signalling Option .....	9
<b>Supplementary Services (Network Dependent)</b> .....	9
Call Waiting .....	9
Three-Way Calling.....	9
Call Forwarding.....	9
Caller ID .....	10
<b>Fax and Data Transmission</b> .....	10
Fax and Data Applications .....	10
Originating Fax and Data Calls .....	11
Receiving Fax and Data Calls.....	11
<b>Phonecell SX4e User Setup</b> .....	12
How to Enter the User Setup Mode.....	12
<b>User Setup Commands</b> .....	12
In-Call DTMF Signalling Option .....	12
Auto Send Delay .....	12
Pulse Dial Option .....	12
Enable/Disable Zero Dial Delay for Frequently Called Numbers.....	13
Audio Output Level Control.....	13
Caller ID Format Selection.....	13
<b>Phonecell SX4e Technician Programming Commands</b> .....	14
<b>Phonecell SX4e Troubleshooting</b> .....	19
<b>General Information and Safety</b> .....	20
<b>Warranty</b> .....	22

## INSTALLATION

### Antenna Location and Setup

The Phonecell SX4e comes with a standard spike antenna - **See Figure 1**. The Phonecell SX4e comes with a standard spike antenna (TNC). For optimal signal strength, choose an antenna location that is above ground and as close to windows (or exterior walls) as possible - **See Figure 2**. Cellular signal strength is displayed by the Received Signal Strength Indicator (RSSI) LED on the unit - See the *How to Use the LED Status Indicators* section of this guide.

- 1) Connect the antenna to the SX4e - **see Figure 1**.
- 2) Finger-tighten the antenna; do not over-tighten.

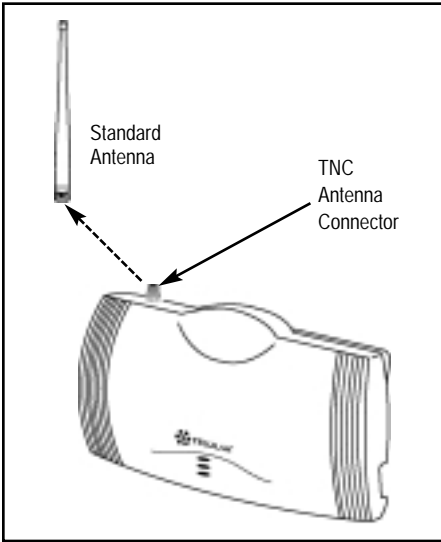

Figure 1 - SX4e antenna installation.

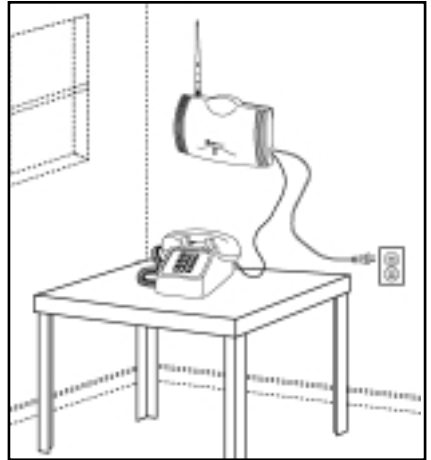

Figure 2 - For optimum signal strength, locate the unit near a window with the antenna pointed upward.

### Optional Wall-Mount Installation

After you've selected a location and made all the necessary connections and adjustments, your **SX4e** is ready for wall-mounting.

- 1) To mount the Phonecell SX4e on a wall, mark two hole locations 166 mm (6-17/32 inches) apart. These hole locations match the mounting hooks on the back of the unit - **see Figure 3**.
- 2) Install the screws (not supplied), leaving a gap (approximately 3mm (1/8 inches)) between screw head and wall.
- 3) Mount the FWT onto the screws - **see Figure 4**.

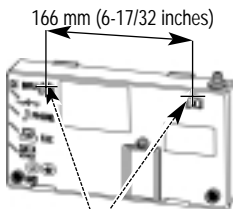

Figure 3 - Mounting hooks for optional wall mounting.

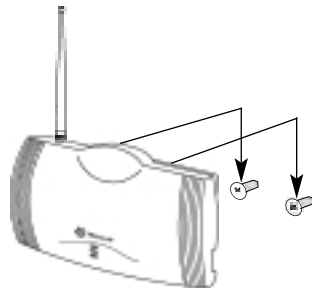

Figure 4 - Mount the SX4e onto the screws in the wall.

## Connect Your SX4e to AC Power

1) A protective earth (safety ground) terminal (screw) marked with this protective earth symbol is provided on the back of the SX4e Phonecell unit. Connect this terminal to a good earth ground (i.e., a cold water pipe) by means of an 18 gauge or heavier insulated wire. The wire insulation should be green with a yellow stripe to indicate that this is a protective earth (safety ground) connection - **see Figure 5**.



Protective earth  
(safety ground)  
terminal screw

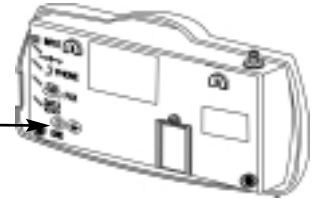

Figure 5 - Protective earth terminal screw.

2) Connect the Line Cord from the AC power source to the Power Supply.

3) Connect the barrel plug on the Power Supply to the Power Input port marked "DC Input", on the side of the SX4e.

**NOTE:** An optional battery back up unit (*not supplied*) may be used instead of the Power Supply - **see Figure 6**. Follow the battery installation instructions provided with the Backup Unit.

4) The LED Power Status indicator (located on the front of the FWT) will turn green immediately upon connecting to power.

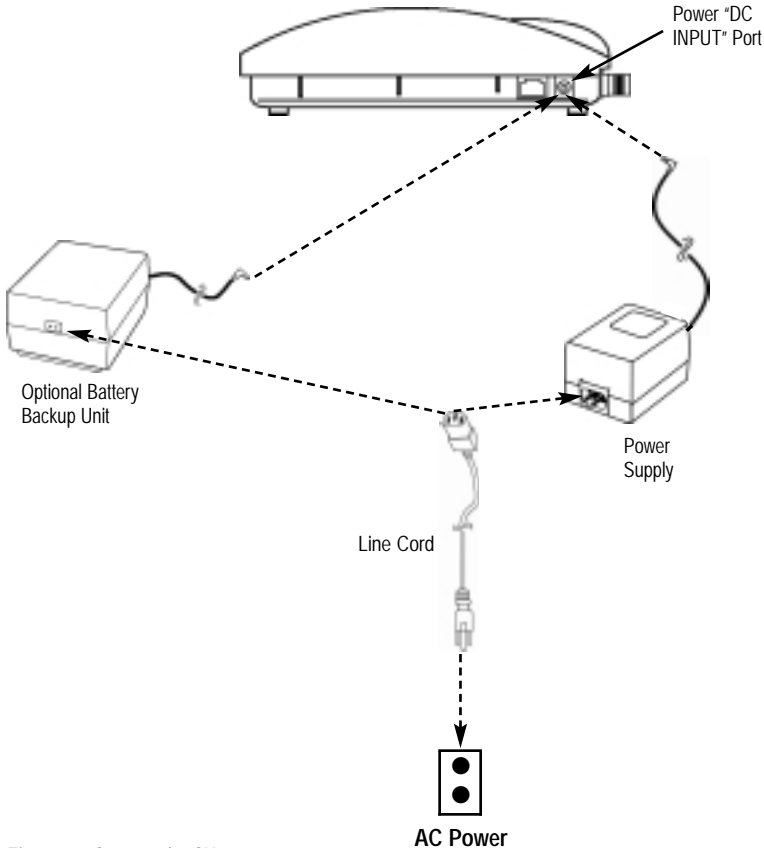

Figure 6 - Connect the SX4e to power.

## Plug in Your Telephone

- 1) Locate the modular line port on your phone and plug in one end of a standard phone cord.
- 2) Connect the other end of the cord to the telephone port on the side of your SX4e - **see Figure 7.**  
**NOTE:** An RJ-11 connector will fit into the phone port.  
**NOTE:** The SX4e does not support direct computer modem (data) operation through the phone port or fax port. See the *Digital Data Service* section of this manual for computer digital data operation.
- 3) To add more telephones, plug in a line splitter (not supplied) to the phone port - **see Figure 8.**  
**NOTE:** The SX4e will only let you make one phone call at a time.

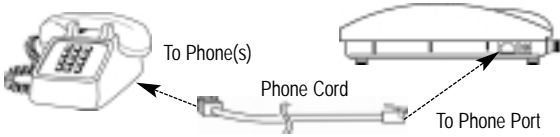

Figure 7- Connect the SX4e to a telephone.

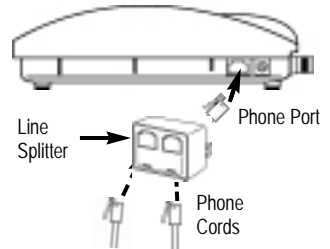

Figure 8 – An optional Line Splitter lets you connect additional phones to your Phonocell SX4e.

## HOW TO SET UP YOUR PHONE NUMBER

Your SX4e has been designed for easy setup and installation. You can program the Phonecell SX4e with an ordinary tone-dial (DTMF) telephone, which is sometimes referred to as a POTS (Plain Old Telephone Service) phone. Note: This programming mode is not accessible while you're in a call.

Before you begin programming, connect the antenna, plug in the power, and connect a tone-dial (DTMF) telephone.

1) Pick up the POTS telephone handset and listen for a tone (either a steady dial tone or a beeping no-service tone).

2) **Press: # \* 0 \* 1 2 3 4 4 3 2 1 #**

The tone will change to a different, steady "Programming" tone and the bottom LED indicator on the Phonecell will blink alternately RED and GREEN to indicate that you're in programming mode. You now have two minutes to start the programming steps.

3) **Press: # \* 1 \* <MIN> #**

This key sequence is used to enter your 10-digit telephone number (Mobile Identification Number, or MIN). If you enter the number incorrectly, you'll hear 3 short tones followed by the programming tone. If you enter the number correctly, you'll hear the programming tone again. If the MIN phone number value is not 10 digits, it is considered invalid and the FWT will not update or store this value; the currently stored value will remain.

4) **Press: # \* 5 \* <SID> #**

This key sequence is used to enter the 1- to 5-digit System Identifier, or SID. This information identifies your cellular service company. If you enter the SID incorrectly, you'll hear three short tones followed by the programming tone; if correct, you'll hear the programming tone again. If the SID value is not in the range of 0 to 32,767, it is considered invalid. The factory default is **69**.

5) **Press: # \* 4 \* <paging channel> #**

This key sequence is used to set up your 1- to 4-digit initial paging channel. When you turn on your Phonecell, this channel helps the service provider find you-and vice-versa. If the paging channel is not in the range of 1 to 1023, it is considered invalid. Channels 800 to 990 are invalid. The factory default channel setting is **333**.

6) **Press: # \* 7 \* <band order> #**

This key sequence is used to enter the band order. The band order value is a series of digits between 1 and 2 (1 and 8 for Tri-Mode model) that must be at least 1 digit and not more than 2 digits (8 digits for Tri-Mode model) long. The following table describes the relationship between the band order digits and EIA/TIA-136 system/band assignment:

<b>Band Order Digits</b>		<b>EIA/TIA-136</b>	
1		<b>System A (800 MHz)</b>	} TDMA 800 model
2		<b>System B (800 MHz)</b>	
3	} Digital Tri-Mode model	<b>Band A (1900 MHz)</b>	
4		<b>Band B (1900 MHz)</b>	
5		<b>Band C (1900 MHz)</b>	
6		<b>Band D (1900 MHz)</b>	
7		<b>Band E (1900 MHz)</b>	
8		<b>Band F (1900 MHz)</b>	

The factory default is **12** for the TDMA 800 model and **34125678** for the Tri-Mode model.

7) Hang up the phone. The flashing LED indicator will become solid GREEN. Phone Number Setup is complete.

# PHONECELL SX4e OPERATION

## How to Use the LED Status Indicators

- Plug in the power supply.
- Wait for the unit to initialize.
- The three LED indicators on the front of your Phonecell will turn ON. The Tables below describe the modes and operation of the three indicators - see **Figures 9 and 10**.

### LED 1 – Power Status Indicator

LED Color	LED Activity	Description
GREEN	Continuous	FWT Power ON
ORANGE	Continuous	Low-Voltage Detection
NONE (Dark)	None	No FWT Power

### LED 2 – Cellular Status Indicator

LED Color	LED Activity	Description
GREEN	Continuous	Good Cellular Signal Strength
GREEN	Flashing	Poor Cellular Signal Strength
RED	Continuous	No Cellular Service*

\*Contact your service provider to verify that cellular service is activated.

### LED 3 – FWT Status Indicator

LED Color	LED Activity	Description
GREEN	Continuous	Normal Operation
GREEN	Flashing	Normal Operation - Analog Fax Call
GREEN/RED	Alternating	Programming Mode
RED	Continuous	FWT Failure**
RED	Flashing	Phone or Fax Interface Failure Check Wiring to Telephone

\*\*Contact your Authorized Telular Service Representative

## How to Place a Call

- 1) Pick up your telephone handset (your phone is now “off-hook”).
- 2) Listen for dial tone (If service is not available, a No-Service tone is produced. Hang up the phone and try again. If the No-Service tone continues, contact your service provider to make sure cellular service is activated.).
- 3) Dial the phone number.

## How to Receive a Call

When your telephone rings, pick up the handset and begin talking.

## How to End a Call

Hang-up the phone (place the handset back onto the telephone cradle).

## The Hookflash Function

When you initiate the Hookflash function, it automatically lets you:

- Speed up the connection after you dial a phone number.
- Answer an incoming call that occurs when you’re dialing a phone number.
- Use special (supplementary) cellular services which may be available in your cellular service area.

## How to Use the Hookflash Function

Depending upon your phone, there are two ways to initiate the Hookflash function:

- Press the dedicated “HOOKFLASH” or “FLASH” key on your telephone.
- Press the hang-up or switch-hook mechanism on your phone once quickly (approximately 1/2-second).

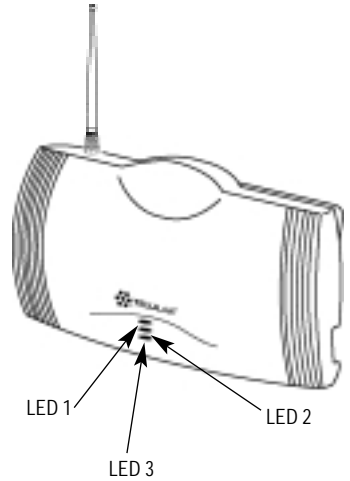

Figure 9 - LED status indicators.



## Important Tones and Alerts

**No-Service Tone** – When cellular service is not available, the receiver emits a No-Service (fast-beeping) tone instead of the normal (steady) dial tone.

**ROH (Receiver Off-Hook) Tone** – If the telephone equipment remains off-hook (off its cradle) with no dialing activity for 30 seconds, the receiver emits an ROH tone for 45 seconds.

**Incoming Call Alert** – If you're dialing a number and an incoming call occurs, the receiver will emit an audible ring. To answer the incoming call:

- Press the "HOOKFLASH" button once. This will connect the incoming call.
- OR hang-up immediately. This will cause the phone to start ringing.

**Roam Dial Tone** – When cellular service is available, but the SX4e is in a Roam area, the receiver may emit a different dial tone to indicate the roaming condition. However, unless the FWT is reprogrammed in the field, the factory default tone is set the same as normal service dial tone.

## How to Adjust the Volume Level

If the volume level on your phone is too high or too low, you can adjust the levels using the keypad on your telephone.

**Note:** your telephone must be in Tone-Dial (DTMF) mode to adjust the levels.

**To Increase Audio Level** - Increase the audio level in steps by pressing:

**Press:** # \* 8 (also known as # \* Up)

Continue to press # \* 8 until the desired level is reached.

**To Decrease Audio Level** - Decrease the audio level in steps by pressing:

**Press:** # \* 3 (also known as # \* Down)

Continue to press # \* 3 until the desired level is reached..

**NOTE:** The default setting lets you adjust the audio up to three (3) steps from the default volume in either direction (Up or Down). The volume setting remains in effect for future calls until changed manually, even if the telephone is on-hook. If the SX4e power is cycled (turned OFF/ON), the default mid-range volume setting will be restored.

## Variable Dial Time (Auto SEND Delay) Option

When you place a call, your Phonecell SX4e automatically sends the phone number over the cellular network after you dial the last digit. However, to make sure you have enough time to dial the last digit, a 3-second Auto SEND Delay is programmed into the unit at the factory. To change the Auto SEND Delay setting, see the User Programming Commands section of this manual.

## In-Call DTMF Signaling Option

Depending upon your cellular provider, the Data After SEND option may need to be Enabled or Disabled to use special cellular features such as call waiting, three-way conference calls, voice mail, etc. Please consult your service provider for the required In-Call DTMF Signaling configuration.

The factory default setting is 0 (In-Band Signaling only). To change the Data After Send setting, see the How To Set the Auto SEND Delay in the Phonecell SX4e Programming section of this manual.

## SUPPLEMENTARY SERVICES (NETWORK DEPENDENT)

### Call Waiting

Call Waiting enables you to be alerted to an incoming call while you are already on a call. You have the option of responding to the second call while putting the first call on hold. You can also disable the call waiting option during a particular call. Contact your service provider to activate Call Waiting.

### Three-Way Calling

Three-Way Calling enables you to set up a three-way conversation with two other different numbered users. Contact your service provider to activate Three-Way Calling.

### Call Forwarding

Call Forwarding enables you to forward all your incoming calls to another phone number, even if your telephone is turned off. You can continue to make calls from your telephone when Call Forwarding is activated. Contact your service provider to activate Call Forwarding.

## Caller ID

The Phonecell SX4e sends information to an external Caller ID device to allow presentation of the calling party's telephone number, if this service is available from the network. Caller ID boxes in compliance with ETSI 300 659 or Bellcore GR-30-CORE standards are supported. Only type 1 (on-hook) presentation is supported. Because there is no source of date and time available to the FWT, the displayed date and time will be arbitrary.

Three Caller ID message formats are available to satisfy the requirements of currently available Caller ID devices:

- Multiple Data Message Format (MDMF) with blank date and time fields (this selection will work for most currently available caller ID devices).
- Multiple Data Message Format (MDMF) with date and time information fixed at midnight, January 1.
- Single Data Message Format (SDMF) with date and time information fixed at midnight, January 1

Contact your service provider to activate Caller ID.

## **FAX AND DATA TRANSMISSION**

### **Fax and Data Applications**

When considering using a device other than a telephone in conjunction with the Phonecell SX4e (such as a modem), consider if that device would plug directly into the Fax jack on the premise and work with a normal telephone line. If the answer is 'yes', you can use that device with the Phonecell SX4e; if the answer is 'no', that device will most likely not work in this application.

Multi-extension installations - For a multi-extension installation, make sure that all the extensions are on-hook. If one extension is off-hook (not hung up), none of the extensions on that line will ring when a call is being received.

### **Facsimile Machines**

A facsimile machine needs to be connected exactly as it needs to be configured for use on a regular wired telephone company line. Some models of portable facsimile machines require an external telephone for normal operation. These models still need this external telephone when hooked up to the Phonecell SX4e. A splitter may be required.

### **Fax and Data Transmission Overview**

The Phonecell SX4e operates on TDMA 800 MHz and PCS 1900 MHz digital networks and on AMPS 800 MHz analog networks. Because most TDMA and PCS networks do not support digital fax and data services, AMPS 800 MHz networks and AMPS 800 MHz channels on TDMA 800 MHz networks can be used for fax and data services. Contact your local cellular dealer or service provider to determine the availability of an AMPS analog network.

To make a fax or data-modem call, a special dial sequence to request an analog channel **MUST** be entered just before the call is made. Do not use this dial sequence for a voice call.

If the request is successful, the normal fax or data rate negotiations will commence and the call will continue. The analog channel assignment lasts for the duration of the call.

**NOTE:** There is no guarantee that the analog channel request will be granted (there may be no analog channel available). The fax or data call will fail if an analog channel is not assigned. Contact your local cellular dealer or service provider to determine the availability of an analog channel. The SX4e automatically adjusts the transmit and receive audio levels for optimum data transmission when a fax or modem is detected. After the completion of the call, the audio levels are returned to the user's previous settings (patent pending).

The SX4e is compatible with all group 3 facsimile machines and computer modems. Normally, data transmission rates of up to 9600 baud are possible dependent upon the type of modem used and your cellular service provider's capability.

The SX4e's Status LED will indicate when an analog call has been initiated - see the *How to Use the LED Status Indicators* section of this manual.

## Originating Fax and Data Calls

### Sending a Fax Message

- 1) Set up your fax machine just as you would for a wired telephone line.
- 2) If your fax machine has a 'prefix' setting, set it to # \* 2. If your program does not have such a setting, add # \* 2 to the phone number as shown in the example below:

Example: If you are sending to 1-800-123-4567, enter #\*218001234567. The '# \* 2' tells the SX4e to use the analog mode for this call only.

- 3) Your fax should then proceed normally.

**NOTE:** If the network does not have analog channels available, the call will be unsuccessful. Try the call at a later time.

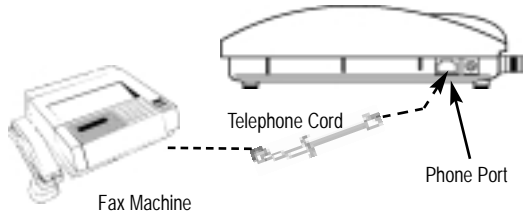

Figure 11 - Connecting a fax machine to the SX4e.

### Sending Data

- 1) Connect your computer modem to the Phonecell SX4e exactly the same way you would to wired telephone service.
- 2) If your modem communications program has a 'prefix' setting, set it to # \* 2. If your fax machine does not have such a setting, add # \* 2 to the phone number as shown in the example below:

Example: If you are sending to 1-800-123-4567, enter #\*218001234567. The '# \* 2' tells the Phonecell to use the analog mode for this call only.

- 3) Your data transmission should then proceed normally.

**NOTE:** If the network does not have analog channels available, the call will be unsuccessful. Try the call at a later time.

**NOTE:** As a result of using this dial string prefix, the SX4e will be placed in the analog mode and an analog channel will be requested before the call is dialed. If the request is successful, the data rate negotiations will commence and the call will continue. The "FWT Status" LED will indicate an analog call by flashing green.

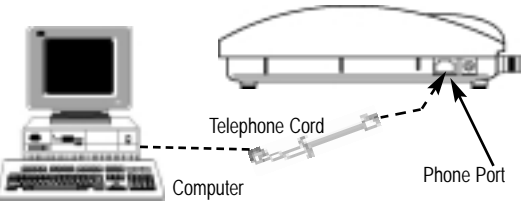

Figure 12 - Connecting a computer to the SX4e.

## Receiving Fax and Data Calls

When your fax machine or modem answers a call, the Phonecell will decode the answer tone from the local device. This will cause the Phonecell to go to analog mode, regardless of which mode is currently set, to receive the data or fax. The "FWT Status" LED will indicate an analog call by flashing green. You do not need to do anything to allow your unit to receive fax or data calls. However, the facsimile machine and/or computer data modem must be connected to the Phonecell SX. (See: Step by Step Fax Instructions). If the call is not completed successfully, the remote caller should retry the call immediately. The Phonecell SX4e will remain in analog mode for a short time after call failure waiting for retry.

### Refresh FWT to Digital Mode

When the analog fax/data call ends, the "FWT Status" LED will return to continuous green indicating the FWT has returned to its normal operating digital mode.

## **PHONECELL SX4e USER SETUP**

The SX4e can be programmed with an ordinary telephone, which is sometimes referred to as a POTS (Plain Old Telephone Service) phone.

**NOTE:** The User Setup mode is not accessible while you're in a call.

In the following sections, an **<entered value>** is comprised of the digits **0** through **9**. The digits **'\*'** and **'#'** are considered invalid when used inside an **<entered value>**, and will cause that command/value to be rejected.

**If there are no key entries within any 2-minute period, the FWT will revert to its normal mode. Going on-hook (hanging up the phone) will exit the setup mode.**

Correct entry of the commands below will be confirmed by the return of the programming tone, which signifies that the unit is ready to accept the next entry. Incorrect entry will result in a short, three tone sequence of rising frequencies, followed by the return of the programming tone, which again signifies that the unit is ready to accept the corrected entry.

### **How to Enter the User Setup Mode**

Use the following access code to enter the User Setup mode:

**Press:   # \* 0 \* 1 2 3 4 5 6 7 8 #**

The access code is 8 digits. If the access code is not 8 digits or does not match the access code, the Programming mode cannot be entered. This code is pre-programmed during production and cannot be changed.

If you enter the access code correctly, the dial tone should change to a different, steady "Programming" tone and the bottom LED indicator on the front of the Phonecell will blink alternately RED and GREEN to indicate that you're in the programming mode.

## **USER SETUP COMMANDS**

### **In-Call DTMF Signaling Option**

Use the following key sequence to set the In-Call DTMF Signaling option:

**Press:   # \* 10 \* <In-Call DTMF option> #**

The **< >** brackets represents the 1-digit in-call DTMF signaling option.

**Enter**       0 for In-Band Signaling;  
              1 for Out-of-Band Signaling;  
              2 for both In-Band and Out-of-Band signaling;  
              3 for neither.

Enter a value between 0 and 3, otherwise the FWT will not update or store this value; the existing stored parameter will remain. The factory default setting is **1** (Out-of-Band signaling).

### **Auto SEND Delay**

Use the following key sequence to set the Auto SEND Delay

**Press:   # \* 11 # \* <Auto SEND Delay> #**

Enter a value between 2 and 20 seconds, otherwise the Phonecell will not update or store this value; the existing stored parameter will remain. The factory default setting is **3 seconds**.

### **Pulse Dial Option**

Use the following key sequence to set the Pulse Dial option:

**Press:   # \* 12 \* <Pulse Dial option> #**

**Enter:    0** to disable pulse dialing capability  
          **1** to enable pulse dialing capability.

Enter either 0 or 1, otherwise the Phonecell will not update or store this value; the existing stored parameter will remain. The factory default setting is **1**.

## Enable/Disable Zero Dial Delay for Frequently Called Numbers

Use the following key sequence to set the Zero Dial Delay option:

**Press:**     **# \* 21 \* <Zero Dial Delay option> #**

**Enter:**     **0** to disable Zero Dial Delay option

**1** to enable Zero Dial Delay option.

Enter either 0 or 1; otherwise the Phonecell will not update or store this value; the existing stored parameter will remain. The factory default setting is **1**.

## Audio Output Level Control

Use the following key sequence to program the nominal audio output level:

**Press:**     **# \* 69 \* <output level> #**

The output level value is set to 0 for low , **1** for normal, and **2** for high. If the output level value is greater than 2, it will be considered invalid. The factory default is **1**.

## Caller ID Format Selection

The following key sequence is used to enter the Caller ID format selection:

**Press:**     **# \* 84 \* <CID format> #**

The CID format value is set to **0** to select a CID Multiple Data Message Format (MDMF) with no date or time information; set to **1** to select a CID MDMF with date and time information fixed at midnight, January 1; set to **2** to select a CID Single Data Message Format (SDMF) with date and time information fixed at midnight, January 1. If the CID format value is greater than 2, it is considered invalid. The factory default is **0**.

## PHONECELL SX4e TECHNICIAN PROGRAMMING COMMANDS

### IMPORTANT!

*The Phonecell SX4e is capable of **over-the-air activation**. Please contact your local cellular service provider for more information.*

### IMPORTANT!

*The following commands may be used by a trained service technician to change the configuration of the Phonecell FWT. **WARNING: These commands are intended for use by trained service technicians only. Untrained users could damage the Phonecell, violate local regulations and breach the service agreement with the cellular provider. For further assistance, please contact your Authorized Telular Representative.***

### How to Enter the Technician Programming Mode

Use the following access code to enter the Technician Programming mode:

**Press: # \* 0 \* 1 2 3 4 4 3 2 1 #**

The access code is 8 digits. If the access code is not 8 digits or does not match the access code, the Programming mode cannot be entered. This code is pre-programmed during production and cannot be changed in the field.

If you enter the access code correctly, the dial tone should change to a different, steady "Programming" tone and the bottom LED indicator on the front of the Phonecell will blink alternately RED and GREEN to indicate that you're in the programming mode.

### Mobile Identification Number (MIN)

The following key sequence is used to enter the FWT phone number:

**Press: # \* 1 \* <MIN> #**

If the MIN phone number value is not 10 digits, it is considered invalid and the FWT will not update or store this value; the currently stored value will remain.

### Access Overload Class (ACCOLC)

The following key sequence is used to enter the ACCOLC:

**Press: # \* 2 \* <ACCOLC> #**

If the ACCOLC is not in the range of 0 to 15, it is considered invalid. The factory default is 2.

### First Paging Channel

The following key sequence is used to set up the first paging channel:

**Press: # \* 4 \* <paging channel> #**

If the paging channel is not in the range of 1 to 1023, it is considered invalid. Channels 800 to 990 are invalid. The factory default channel setting is 333.

### Home System Identification (SID)

The following key sequence is used to enter the home SID:

**Press: # \* 5 \* <SID> #**

If the SID value is not in the range of 0 to 32,767, it is considered invalid. The factory default is 69.

### Dial Tone After Remote On-Hook Option

The following key sequence is used to enter the dial tone after remote on-hook option:

**Press: # \* 8 \* <dial tone option> #**

The dial tone value is set to 0 for no tone after a remote on-hook; 1 to enable dial tone after remote on hook. If the value is neither 0 nor 1, it is considered invalid. The factory default is 1.

## Roam Option

The following key sequence is used to enter the roam option:

**Press: # \* 6 \* <home only> \* <SOC disable> #**

When the home only value is set to 0, the Phonecell will use the SOC/SID list specified in the IRDB along with the home SID and home SOC when searching for service, and will search for the highest priority service provider that is not forbidden. When the home only value is set to 1, the Phonecell will use only the home SID and home SOC. If the home only value is not set to 0 or 1, it is considered invalid. The factory default is 0.

SOC disable defines whether the SID or SOC takes priority when classifying a service provider. When the SOC disable value is set to 0, the highest priority classification of either the SID or SOC will take precedence; when set to 1, the SID priority will take precedence. If the SOC disable value is not in the range 0 or 1, it is considered invalid. The factory default is 0.

## Band Order (System) Selection

The following key sequence is used to enter the preferred band order:

**Press: # \* 7 \* <band order> #**

The band order value is a series of digits between 1 and 2 (1 and 8 for Tri-Mode model) that must be at least 1 digit and not more than 2 digits (8 digits for Tri-Mode model) long. The following table describes the relationship between the band order digits and EIA/TIA-136 system/band assignment:

<u>Band Order Digits</u>		<u>EIA/TIA-136</u>	
1		System A (800 MHz)	} TDMA 800 model
2		System B (800 MHz)	
3	} Digital Tri-Mode model	Band A (1900 MHz)	
4		Band B (1900 MHz)	
5		Band C (1900 MHz)	
6		Band D (1900 MHz)	
7		Band E (1900 MHz)	
8		Band F (1900 MHz)	

The factory default is **12** for the TDMA 800 model and **34125678** for the Tri-Mode model.

## Post Receiver Off-Hook Option

The following key sequence is used to enter the post receiver off-hook option:

**Press: # \* 9 \* <post ROH option> #**

The post ROH value is set to 0 for continuous ROH tone; 1 to disable ROH tone and periodically check for an on-hook condition. If the post ROH value is neither 0 nor 1, it is considered invalid. The factory default is 1.

## System Operator Code

The following key sequence is used to program the system operator code:

**Press: # \* 77 \* <code> #**

If the code value is not in the range of 0 to 4,095, it is considered invalid. The factory default is **0**.

## Emergency Numbers

The following key sequence is used to program the emergency numbers:

**Press: # \* 78 \* <index> <emergency number> #**

The index is a number from **1 to 3** representing the emergency number to be programmed. If the emergency number is less than 3 digits or more than 10 digits, it is considered invalid and the FWT will not update or store this value; the currently stored value will remain. The factory default is an emergency number of **911 in index 1**; indices 2 and 3 are not programmed.

## Call-Answered Supervision Pulse Option

The following key sequence is used to enable or disable the call-answered supervision pulse, select its frequency, and program its duration:

**Press:   # \* 18 \* <cas\_pls\_enable> \* <cas\_pls\_freq> \*  
          <cas\_pls\_duration> \* <cas\_pls\_level> #**

The <cas\_pls\_enable> value is set to 0 to disable the pulse, 1 to enable the pulse. If the value is neither 0 nor 1, it will be considered invalid. The <cas\_pls\_frequency> value is set to 0 for 12 kHz, 1 for 16 kHz. If the value is neither 0 nor 1, it will be considered invalid. The <cas\_pls\_duration> value is programmed in 1 ms increments from 10 to 65535 (10 - 65,535 ms). If the value is not between 10 and 65535, inclusive, it will be considered invalid. The cas\_pls\_level can be programmed to any of the values shown in the table below. If the cas\_pls\_level is not between 0 and 6, inclusive, it will be considered invalid. The factory default is **0, 0, 100 and 3**.

## Line-Reversal Outgoing Option

The following key sequence is used to enable or disable line (tip/ring) reversal for outgoing calls:

**Press:   # \* 22 \* <line\_reversal\_outgoing> #**

The line-reversal outgoing value is set to 0 to disable line reversal, 1 to enable line reversal. If the value is neither 0 nor 1, it is considered invalid. The factory default is **0**.

## Line-Reversal Incoming Option

The following key sequence shall be used to enable or disable line (tip/ring) reversal for incoming calls:

**Press:   # \* 23 \* <line\_reversal\_incoming> #**

The line-reversal incoming value is set to 0 to disable line reversal, 1 to enable line reversal. If the value is neither 0 nor 1, it is considered invalid. The factory default is **0**.

## A-Key

The following key sequence is used to enter the A-Key:

**Press:   # \* 27 \* <A-Key> #**

If the A-Key is less than 6 digits or more than 26 digits, it is considered invalid and the FWT will not update or store this value; the currently stored value will remain.

## On-Hook Call Alert Cadence Option

The following key sequence will be used to program the on-hook call alert ring cadence:

**Press:   # \* 30 \* <on-time> \* <off-time> #**

Both the on-time and off-time durations are programmed in 100 ms increments from 1 to 255 (0.1 - 25.5 seconds). If the value is not between 1 and 255, inclusive, it will be considered invalid. The factory default is **20 and 40**, respectively.

## On-Hook Call Alert Frequency Option

The following key sequence will be used to program the on-hook call alert ring frequency:

**Press:   # \* 32 \* <frequency> #**

The frequency value is set to 0 for 20 Hz, 1 for 25 Hz, and 2 for 50 Hz. If the frequency value is greater than 2, it will be considered invalid. The factory default is **0**.

## Audio Input Impedance Option

The following key sequence is used to select the audio input impedance:

**Press:   # \* 68 \* <audio Z> #**

The audio Z value is set to 0 for 600 ohms, 1 for 900 ohms. If the value is neither 0 nor 1, it is considered invalid. The factory default is **0**.



## Ring Back request

The following key sequence is used to request immediate ring back:

**Press: # \* 13 \* #**

There is no ring back value to be set; the command activates when the phone is placed back on-hook.

## Restore Factory Defaults Request

The following key sequence is used to request restoration of all factory set default values (except the NAM information):

**Press: # \* 15 \* #**

There is no restore defaults value to be entered; the command activates immediately. If a value is entered, it is considered invalid and the Phonecell will not restore the factory defaults.

## Periodic Self Test Option

The following key sequence is used to program periodic self test:

**Press: # \* 76 \* <self-test interval> #**

The self-test interval is programmed in 1 second increments from 1 to 65,535. A value of 0 disables periodic self test. If the value is not between 0 and 65,535, inclusive, it will be considered invalid. The factory default is **180**.

## Disconnect Pulse Option

The following key sequence is used to enter the disconnect pulse option:

**Press: # \* 79 \* <disconnect pulse> #**

The disconnect pulse value is programmed in 1 millisecond increments from 10 to 65,535. A value of 0 disables the disconnect pulse. If the value is not between 10 and 65,535, inclusive, it will be considered invalid and the FWT will not update or store this value; the currently stored value will remain. The factory default is **700**.

## Dial Tone Frequency Selection Option

The following key sequence is used to select the dial tone frequency option:

**Press: # \* 80 \* <dial tone frequency> #**

The dial tone frequency value is set to 0 to select the North American dial tone frequency pair (350 + 440 Hz); set to 1 to select European dial tone frequency (425 Hz). If the dial tone frequency selection option value is neither 0 nor 1, it is considered invalid and the FWT will not update or store this value; the currently stored value will remain. The factory default is **0**.

## Non-Standard Control Channel Option

The following key sequence is used to select the non-standard control channel option:

**Press: # \* 88 \* <non-standard option> #**

The non-standard option is set to 0 to disable non-standard control channels; set to 1 to enable. This option applies to AMPS systems only. The factory default is **0**.

## Primary A-Side Non-Standard Control Channel Option

The following key sequence is used to select the non-standard primary control channel range for A-side AMPS systems:

**Press: # \* 89 \* <first ACC> \* <last ACC> #**

The first ACC and last ACC values must be in the range of 0-799 or 991-1023. If the value is not in the range, it will be considered invalid and the FWT will not update or store this value; the currently stored value will remain. The factory default for **first ACC is 333** and for **last ACC is 313**.

### Primary B-Side Non-Standard Control Channel Option

The following key sequence is used to select the non-standard primary control channel range for B-side AMPS systems:

**Press: # \* 90 \* <first ACC> \* <last ACC> #**

The first ACC and last ACC values must be in the range of 0-799 or 991-1023. If the value is not in the range, it will be considered invalid and the FWT will not update or store this value; the currently stored value will remain. The factory default for **first ACC is 334** and for **last ACC is 354**.

### Secondary A-Side Non-Standard Control Channel Option

The following key sequence is used to select the non-standard secondary control channel range for A-side AMPS systems:

**Press: # \* 91 \* <first ACC> \* <last ACC> #**

The first ACC and last ACC values must be in the range of 0-799 or 991-1023. If the value is not in the range, it will be considered invalid and the FWT will not update or store this value; the currently stored value will remain. The factory default for **first ACC is 708** and for **last ACC is 688**.

### Secondary Control Channel Option

The following key sequence is used to select the non-standard secondary control channel range for B-side AMPS systems:

**Press: # \* 92 \* <first ACC> \* <last ACC> #**

The first ACC and last ACC values must be in the range of 0-799 or 991-1023. If the value is not in the range, it will be considered invalid and the FWT will not update or store this value; the currently stored value will remain. The factory default for **first ACC is 737** and for **last ACC is 757**.

### Secondary Paging Channel Option

The following key sequence is used to select the secondary paging channel AMPS systems:

**Press: # \* 93 \* <paging chan> #**

The paging channel value must be in the range of 0-799 or 991-1023. If the value is not in the range, it will be considered invalid and the FWT will not update or store this value; the currently stored value will remain. The factory default for is **708**.

## **PHONECELL SX4e TROUBLESHOOTING**

### **Telephone Service is Not Working**

If the telephone service is not working, first check the operation of the telephone equipment and wiring connected to your Phonecell. Test the equipment on a different service or piece of equipment to ensure proper operation, or connect a known good telephone device to the Phone port on the Phonecell unit. This will verify the condition of the telephone equipment and the internal wiring of the telephone service to ensure that it's working properly. If the telephone system or wiring is not working properly, replace or repair the equipment as required. Otherwise, contact your cellular provider or your authorized Telular distributor.

### **Unable to Receive Incoming Calls**

If more than one telephone or telephone device is connected to your Phonecell, make sure that all devices are "on-hook" (hung up). If one extension is "off-hook" (off its cradle), none of the extensions on your phone line will ring when an incoming call occurs.

### **Unable to Send and Receive Fax or Data Calls**

Because most TDMA and PCS networks do not support digital fax and data services, AMPS 800 MHz networks and AMPS 800 MHz channels on TDMA 800 MHz networks can be used for fax and data services. There is no guarantee that the analog channel request will be granted (there may be no analog channel available). The fax or data call will fail if an analog channel is not assigned. Contact your local cellular dealer or service provider to determine the availability of an analog channel.

### **Moisture or Ventilation Problems**

Visually inspect your Phonecell unit's enclosure. Moisture can damage the equipment. Ventilation is also very important. If there are moisture or ventilation problems, move your Phonecell to correct as necessary, see the Temperature Environment section of this manual.

### **No Power**

The top LED lamp on the front of your Phonecell SX4e indicates the unit's power condition. If the LED is ORANGE or GREEN, your Phonecell is receiving power. If the power cord is connected and the LED lamp is not lit, the Phonecell is not receiving power. Verify that the AC power source and its corresponding circuit breaker are functioning properly.

### **Battery Backup Failure**

If you're using the optional Battery Backup Unit, the unit must be connected to AC power for at least 24 hours to fully charge the batteries before they'll provide back-up power to your Phonecell. Verify that the batteries have been charged for at least 24 hours and that the power source and its corresponding circuit breaker are functioning properly. Then, examine the batteries for physical damage and corrosion. Replace the batteries if necessary.

## **GENERAL INFORMATION AND SAFETY**

### **Temperature Environment**

#### **Operating Temperature:**

From -10°C (14°F) to +50°C (122°F); Up to 95% relative humidity (non-condensing)

#### **Storage Temperature:**

From -20°C (-4°F) to +60°C (140°F); Up to 95% relative humidity (non-condensing)

### **IMPORTANT!**

*To ensure safe and efficient operation, please read the following information and observe these guidelines whenever using your Phonocell SX4e.*



### **WARNING!**

*Only Authorized Service Personnel should remove the cover of your Phonocell. For further assistance, contact your Authorized Telular Representative. Please have the model and serial number ready (model and serial numbers are located on the label on the bottom of the unit).*

Your **Phonocell SX4e** FWT (Fixed Wireless Terminal) functions as both a radio transmitter and receiver. When it is ON, the FWT receives and sends out radio frequency (RF) energy. The **Phonocell SX4e 800** operates in the frequency ranges of between 824 MHz and 894 MHz. The **Phonocell SX4e Tri-Mode** operates in the frequency ranges of between 824 MHz and 894 MHz (Digital TDMA and analog AMPS) and between 1850 MHz and 1990 MHz (Digital PCS). It employs commonly used phase/frequency modulation techniques. When you use your Phonocell SX4e, the cellular system handling your call controls the power level at which your unit transmits.

### **Exposure to RF (Radio Frequency) Energy**

In 1991, the Institute of Electrical and Electronics Engineers (IEEE), and in 1992, the American National Standards Institute (ANSI), updated the 1982 ANSI Standard for safety levels with respect to human exposure to RF energy. After reviewing the available body of research, more than 120 scientists, engineers and physicians from universities, government health agencies and industry developed this updated Standard. In March, 1993, the U.S. Federal Communications Commission (FCC) proposed the adoption of this updated Standard.

The design of your Telular Phonocell SX4e complies with this updated Standard. Of course, if you want to limit RF exposure even further than the updated ANSI Standard, you may choose to control the duration of your calls and operate your phone in the most power-efficient manner.

### **Safe Operation Requirement**

Do not operate your Phonocell SX4e when any person is within 203 mm (8 inches) of the antenna.

### **Antenna Care and Replacement**

Do not use the Phonocell SX4e with a damaged antenna. If a damaged antenna comes into contact with the skin, a minor burn may result. Have your antenna replaced by a qualified technician immediately. Use only a manufacturer-approved antenna. Unauthorized antennas, modifications, or attachments could damage the Phonocell SX4e.

### **Driving**

Check the laws and regulations on the use of cellular products in the areas where you drive. Some jurisdictions prohibit your using a cellular device while driving a vehicle. Even if your jurisdiction does not have such a law, we strongly suggest that, for safety reasons, the driver use extreme caution when operating the cellular device while the vehicle is in motion. Always obey the law.

### **Exposure to Electronic Devices**

Most modern electronic equipment is shielded from RF energy. However, RF energy from cellular devices may affect inadequately shielded electronic equipment.

RF energy may affect improperly installed or inadequately shielded electronic operating and entertainment systems in motor vehicles. Check with the manufacturer or its representative to determine if these systems are adequately shielded from external RF energy. You should also check with the manufacturer of any equipment that has been added to your vehicle.

Consult the manufacturer of any personal medical devices (such as pacemakers, hearing aids, etc.) to determine if they are adequately shielded from external RF energy.

Turn your Phonocell SX4e OFF in health care facilities when any regulations posted in the areas instruct you to do so. Hospitals or health care facilities may be using equipment that could be sensitive to external RF energy.

## **Aircraft**

Turn OFF your Phonecell SX4e before boarding any aircraft.

- Use it on the ground only with crew permission.
- Do not use it in the air.

To prevent possible interference with aircraft systems, U.S. Federal Aviation Administration (FAA) regulations require you to have permission from a crew member to use your cellular phone (or any other cellular product) while the plane is on the ground. To prevent interference with aircraft systems, FCC regulations prohibit using your cellular device while the plane is in the air.

## **Children**

Do not allow children to play with your Phonecell SX4e to prevent damage to the unit.

## **Blasting Areas**

Construction crews often use remote control RF devices to set off explosives. Therefore, to avoid interfering with blasting operations, turn your Phonecell SX4e OFF when in a "blasting area" or in areas posted: "Turn off two-way radio."

## **Potentially Explosive Atmospheres**

Turn your Phonecell OFF when in any area with a potentially explosive atmosphere. It is rare, but your Phonecell or its accessories could generate sparks. Sparks in such areas could cause an explosion or fire resulting in bodily injury or even death.

Areas with a potentially explosive atmosphere are often, but not always, clearly marked. They include fueling areas such as gas stations; below deck on boats; fuel or chemical transfer or storage facilities; areas where the air contains chemicals or particles, such as grain, dust, or metal powders; and any other area where you would normally be advised to turn off your vehicle engine.

Do not transport or store flammable gas, liquid or explosives in the area of your Phonecell or accessories.

Vehicles using liquefied petroleum gas (such as propane or butane) must comply with the National Fire Protection Standard (FPA-58). For a copy of this standard, contact the National Fire Protection Association, One Batterymarch Park, Quincy, MA 02269, Attn: Publications Sales Division.

## **FCC Part 15 Class B Compliance**

This Phonecell® SX4 model has been tested and found to comply with the limits for a Class B digital device, pursuant to Part 15 of the FCC rules. Changes or modifications not expressly approved by Telular Corporation will void your authority to operate the equipment per FCC part 15 paragraph 15.21. These limits are designed to provide reasonable protection against harmful interference in a residential installation. This equipment generates, uses and can radiate radio frequency energy and, if not installed and used in accordance with the instructions, may cause harmful interference to radio communications. However, there is no guarantee that interference will not occur in a particular installation. If this equipment does cause harmful interference to radio or television reception, which can be determined by turning the equipment OFF and ON, the user is encouraged to try to correct the interference by one or more of the following measures:

- Reorient or relocate the antenna.
- Increase the separation between the equipment and the terminal.
- Connect the equipment into an outlet on a circuit different from that to which the terminal is connected.
- Consult your Authorized Telular Distributor or an experienced radio/TV technician for help.

## **IMPORTANT NOTICES - CONTINUED**

### **WARRANTY**

#### **I. WHAT THIS WARRANTY COVERS AND FOR HOW LONG:**

TELULAR CORPORATION ("Telular") warrants to a distributor Buyer, or to a customer only if the customer is a Buyer directly from Telular, that the Products (including accessories) shall comply with the applicable Specifications and shall be free from defects in material and workmanship under normal use and service for a period of fifteen (15) months from date of shipment from Telular. Telular, at its option, shall at no charge either repair, replace or refund the purchase price of the Product during the warranty period, provided it is returned by Buyer in accordance with the terms of this warranty to the Telular designated repair center. Repair or replacement, at Telular's option, may include the replacement of parts, boards or Products with functionally equivalent reconditioned items. Repaired and replacement items are warranted for the balance of the original warranty period. All replaced items shall become the property of Telular. **SUCH ACTION ON THE PART OF TELULAR SHALL BE THE FULL EXTENT OF TELULAR'S LIABILITY HEREUNDER, AND BUYERS EXCLUSIVE REMEDY.** Buyer shall be responsible for all costs and expenses incurred by Buyer including without limitation any handling, labor or transportation charges. **OTHER THAN AFORESAID, THIS EXPRESS WARRANTY IS EXTENDED BY TELULAR TO BUYER ONLY AND NOT TO BUYER'S CUSTOMERS OR USERS OF BUYER'S PRODUCTS.**

#### **II. HOW TO OBTAIN WARRANTY SERVICE**

Product covered under this warranty shall only be accepted from and returned to Buyer's designated repair center. Buyer's dealers, distributors, agents, and end users cannot submit items to Telular under this warranty. To receive warranty service an RMA number must first be obtained from Telular Technical Support. The defective or non-compliant Product should be sent by Buyer freight pre-paid to: Telular Corporation, 647 North Lakeview Parkway, Vernon Hills, IL 60061, USA or other designated location. The product must be packaged in the original carton and packing material or an equivalent package and must have the assigned RMA number clearly marked on the carton. Returned Product received without an RMA number will be returned to the sender.

#### **III. WARRANTY CONDITIONS:**

This is the complete warranty for the Products manufactured by Telular and sold to Buyer. Telular assumes no obligation or liability for additions or modifications to this warranty unless made in writing and signed by an officer of Telular. Unless made in separate written agreement between Telular and Buyer, Telular does not warrant the installation, field maintenance or service of the Products or parts. **TELULAR CANNOT BE RESPONSIBLE IN ANY WAY FOR ANY ANCILLARY EQUIPMENT NOT FURNISHED BY TELULAR WHICH IS ATTACHED TO OR USED IN CONNECTION WITH THE PRODUCTS OR FOR OPERATION OF THE PRODUCTS WITH ANY ANCILLARY EQUIPMENT AND ALL SUCH EQUIPMENT IS EXPRESSLY EXCLUDED FROM THIS WARRANTY. FURTHERMORE, TELULAR CANNOT BE RESPONSIBLE FOR ANY DAMAGE TO THE PRODUCTS RESULTING FROM THE USE OF ANCILLARY EQUIPMENT NOT FURNISHED BY TELULAR FOR USE WITH THE PRODUCTS.**

**WHEN THE PRODUCT IS USED IN CONJUNCTION WITH ANCILLARY OR PERIPHERAL EQUIPMENT NOT MANUFACTURED BY TELULAR, TELULAR DOES NOT WARRANT THE OPERATION OF THE PRODUCT/PERIPHERAL COMBINATION, AND TELULAR SHALL HONOR NO WARRANTY CLAIM WHERE THE PRODUCT IS USED IN SUCH A COMBINATION AND IT IS DETERMINED BY TELULAR THAT THERE IS NO FAULT WITH THE PRODUCT. TELULAR DISCLAIMS LIABILITY FOR RANGE, COVERAGE, AVAILABILITY, OR OPERATION OF THE CELLULAR SYSTEM WHICH IS PROVIDED BY THE CARRIER.**

#### **IV. WHAT THIS WARRANTY DOES NOT COVER:**

(a) Subsequent upgrades and enhancements to the Product. (b) Defects, non-compliance or damage resulting from use of the Product in other than its normal and customary manner or environment. (c) Defects, noncompliance or damage from misuse, lightening, accident or neglect. (d) Defects, noncompliance or damage from improper testing, operation, maintenance, installation, adjustment, or any alteration or modification of any kind. (e) Product disassembled or repaired in such a manner as to adversely affect performance or prevent adequate inspection and testing to verify any warranty claim. (f) Product which has had the serial number removed or made illegible. (g) Defects, non-compliance or damage due to spills of food or liquid. (h) All plastic surfaces and all other externally exposed parts that are scratched or damaged due to customer normal use. (i) Costs and expenses, including without limitation handling, labor and transportation, incurred in returning Product for warranty service to Telular's Repair Center. (j) Repair, programming or servicing by someone other than Telular.

#### V. GENERAL PROVISIONS:

THIS WARRANTY IS GIVEN IN LIEU OF ALL OTHER EXPRESS OR STATUTORY WARRANTIES. IMPLIED WARRANTIES, INCLUDING WITHOUT LIMITATION IMPLIED WARRANTIES OF MERCHANTABILITY, FITNESS FOR A PARTICULAR PURPOSE, TITLE, INFRINGEMENT, DELIVERY, NEGLIGENCE AND PERSONAL INJURY, ARE DISCLAIMED. FURTHER, AS THE CELLULAR CARRIER IS NOT CONTROLLED BY TELULAR, NO WARRANTY IS MADE AS TO COVERAGE, AVAILABILITY OR GRADE OF SERVICE PROVIDED BY THE CELLULAR CARRIER. IN NO EVENT SHALL TELULAR BE LIABLE FOR DAMAGES IN EXCESS OF THE PURCHASE PRICE OF THE PRODUCT, FOR ANY LOSS OF USE, LOSS OF TIME, INCONVENIENCE, COMMERCIAL LOSS, LOST PROFITS OR SAVINGS OR OTHER INCIDENTAL, SPECIAL OR CONSEQUENTIAL DAMAGES ARISING OUT OF THE USE OR INABILITY TO USE SUCH PRODUCT TO THE FULL EXTENT SUCH MAY BE DISCLAIMED BY LAW. SOME JURISDICTIONS DO NOT ALLOW THE EXCLUSION OR LIMITATIONS OF INCIDENTAL OR CONSEQUENTIAL DAMAGES OR LIMITATION ON HOW LONG AN IMPLIED WARRANTY LASTS.

#### VI. SOFTWARE PROVISIONS:

Laws in the United States and other countries preserve for Telular certain exclusive rights for copyrighted Telular software such as the exclusive rights to reproduce in copies and distribute copies of such Telular software. Telular software may be copied into, used in and redistributed with only the Product associated with such Telular software. No other use, including without limitation, disassembly of such Telular software or exercise of exclusive rights in such Telular software is permitted and Telular reserves all rights not expressly granted in this Limited Commercial Warranty.

**Patents:** Telular Corporation products are protected and manufactured under one or more of the following U.S. patents and related international patents and patents pending relating thereto: 4,658,096; 4,737,975; 4,775,997; 4,868,519; 4,922,517; 5,134,651; 5,361,297; 5,469,494; 5,046,085; 5,715,296.

**Trademarks:** Telular Corporation owns the following registered trademarks: TELULAR and design, TELULAR, CELJACK, MAXJACK, TELCEL, HEXAGON LOGO, PHONECELL, CELSERV, TELGUARD, CPX, and AXCELL.



647 North Lakeview Parkway  
Vernon Hills, Illinois 60061, USA  
USA: 1-800-TELULAR (1-800-835-8527)  
Tel: 847-247-9400 • Fax: 847-247-0021  
E-mail: [support@telular.com](mailto:support@telular.com)  
<http://www.telular.com>